



CUSTOMLED

These product instructions have been modified from their original to better suit installation on the 2011-2018 Ducati Diavel as part of the Custom LED Diavel Magic Strobes Brake Light Flasher Kit.

Download FULL SIZE Instructions:
<https://www.customled.com/diavelmsbf>

2011-2018 Ducati Diavel Magic Strobes Brake Flasher®

Installation Instructions

We thank you for purchasing this Custom LED product, which includes the Custom Dynamics® Magic Strobes Brake Light Flasher®. Together, our products utilize the latest technology and high quality components to ensure you the most reliable service and operation. We offer one of the best warranty programs in the industry and we back our products with excellent customer support, if you have questions before or during installation of this product please call Custom LED at +1 (201) 477-0031.

Part Number: 11DIAVEL_BM2_REV0

Package Contents:

- Magic Strobes® Brake Light Flasher Module (1)
- Harness (1)
- Double Sided Tape
- Instructions

Fits: This kit has been supplied by Custom LED to fit the USA SPEC 2011-2018 Ducati Diavel, using the supplied harnesses.

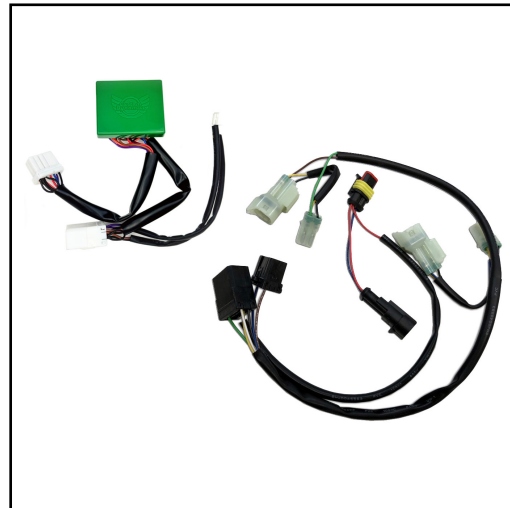

Installation

1. Secure motorcycle on level surface. Remove seat. Disconnect negative battery cable from the battery. Locate and unplug the lighting connector to the rear fender. (See photo right for connector location)
2. Install the harness and module according to the "Illustrated Installation Instructions" (page 3), then return here.
3. Re-connect the battery's negative battery cable to the negative of the battery.
4. Be sure that the Magic Strobes® unit installation location will not interfere with the secure placement of the seat. Secure with tie-wraps, tape or other means so that unit will not move.

Initial Setup and operation

5. Locate the two switches and rotary dial. Be sure the rotary dial is set to position 0. There is small arrow on the dial, this is the pointer that should now be at position 0.
6. Make sure switch 1 & 2 are in the ON position.
7. Select the desired strobe setting listed below with the power off. Always turn power off before changing settings.
8. Turn power on and test for function of the turn signals, running and brake signals with desired setting.
9. Switch 1 enables you to turn the strobe feature on/off on the rear brake lights in this application.
10. Switch 2 is unused. This module supports additional features which are unused in this specific application.



ATTENTION

Please read all Information below before Installation

CAUTION: This kit is intended to control the OEM equipment tail lights only. The use of Incandescent or High Power LEDs (greater than 300ma) will cause the unit to fail.

Important: Module must be secured after installation. Find safe area away from any moving parts and out of the way of normal operation of the bike. Use tie-wraps or other means to secure. Custom Dynamics® and Custom LED are not liable for damage as a result of improperly securing or failing to secure the module.

Important: Dial and switches should be maneuvered by hand only. Do not use any tool such as a screwdriver that could damage waterproof covers.

Important: This module will not work properly if the settings in your BCM (body control module) have been modified from its stock factory configuration.

Caution: A stuck brake switch may cause this unit to overheat and fail. Unplug module immediately if this condition occurs.

Note: Although this device has been designed to significantly increase your braking visibility, flash/strobe patterns may not be street legal in your area. This device is not DOT approved.

Questions? Call us at: 1 (201) 477-0031 Monday-Friday 9:00AM-4:00PM EST

(continued from page 1)

Magic Strokes™ DYN Functions

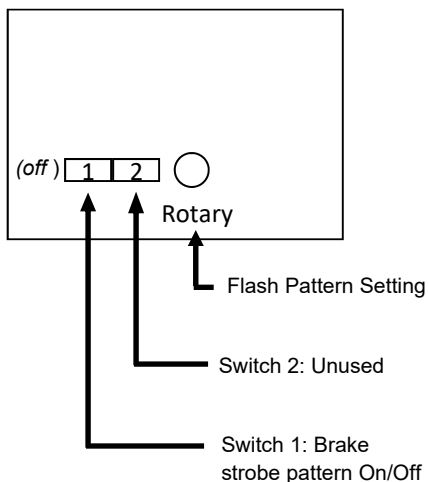

Flash Pattern Information:

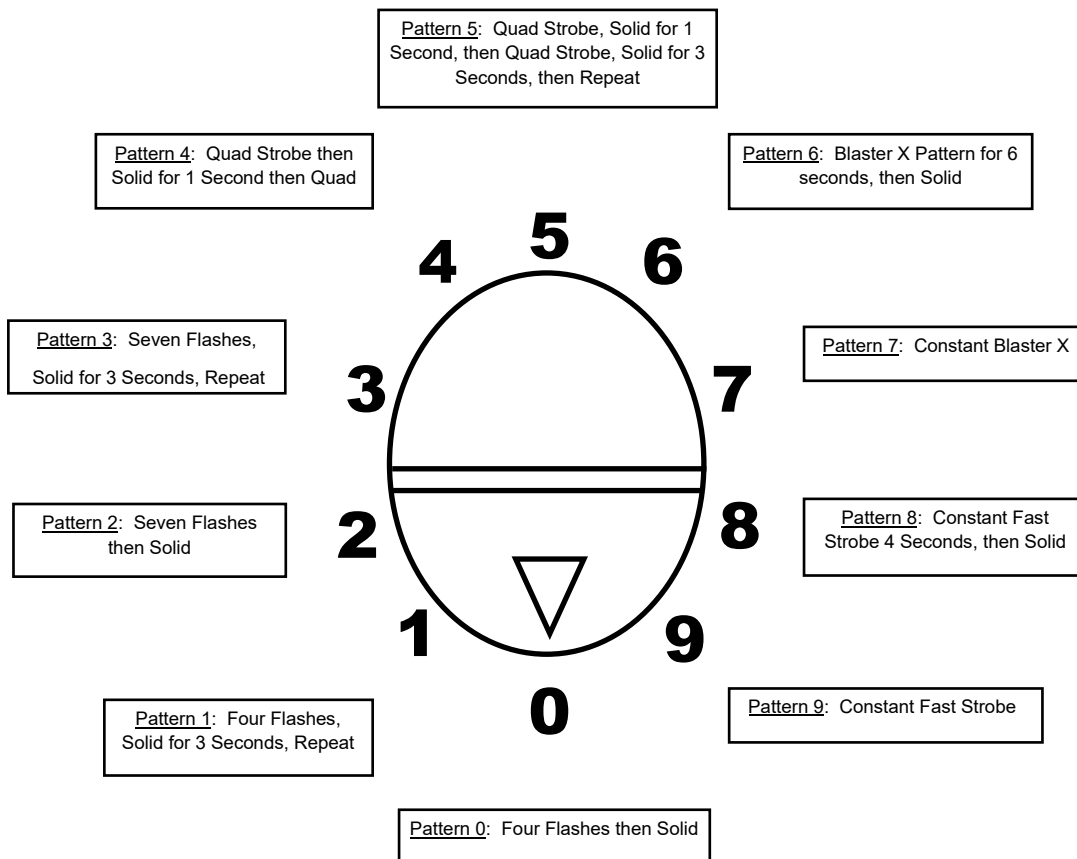

Questions? Call us at: 1 (201) 477-0031 Monday-Friday 9:00AM-4:00PM EST

Illustrated Installation Instructions

Magic Strobes Brake Light Flasher – 2011-2018 Ducati Diavel

1) Remove the riders seat and remove the 6 hex screws which fasten the plastic cover shown.

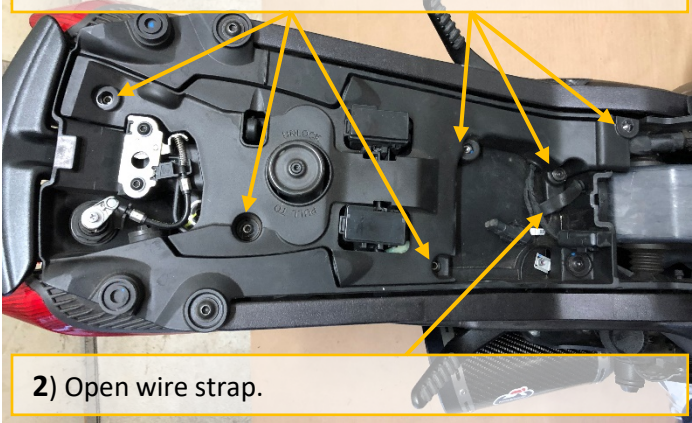

2) Open wire strap.

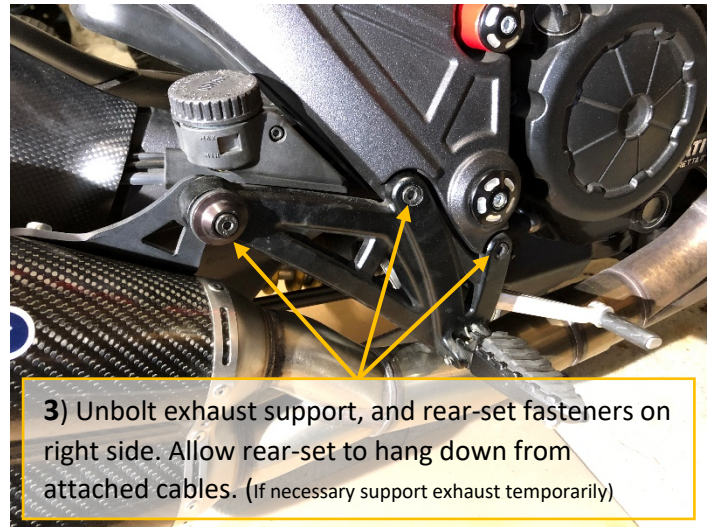

3) Unbolt exhaust support, and rear-set fasteners on right side. Allow rear-set to hang down from attached cables. (If necessary support exhaust temporarily)

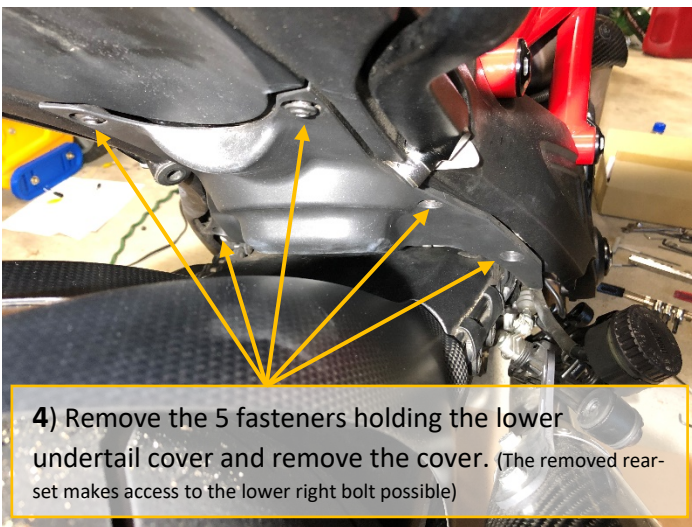

4) Remove the 5 fasteners holding the lower undertail cover and remove the cover. (The removed rear-set makes access to the lower right bolt possible)



5) Locate and disconnect foot-brake connector.

The connector is located on left side of fuel tank among other connectors. Follow the wire from the foot brake switch if necessary. Wire colors are YELLOW on the male, and GRAY/RED and RED on the female). Pull connectors down from beside tank for easier access.

6) Pass the two connectors on provided harness down to lower tank area as shown.

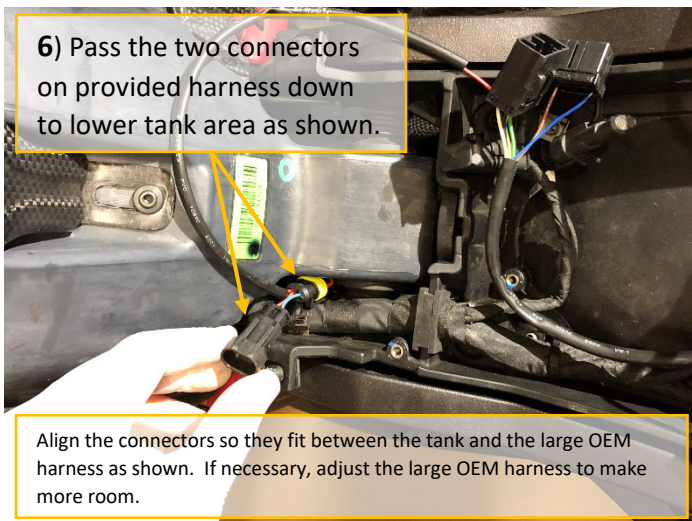

Align the connectors so they fit between the tank and the large OEM harness as shown. If necessary, adjust the large OEM harness to make more room.

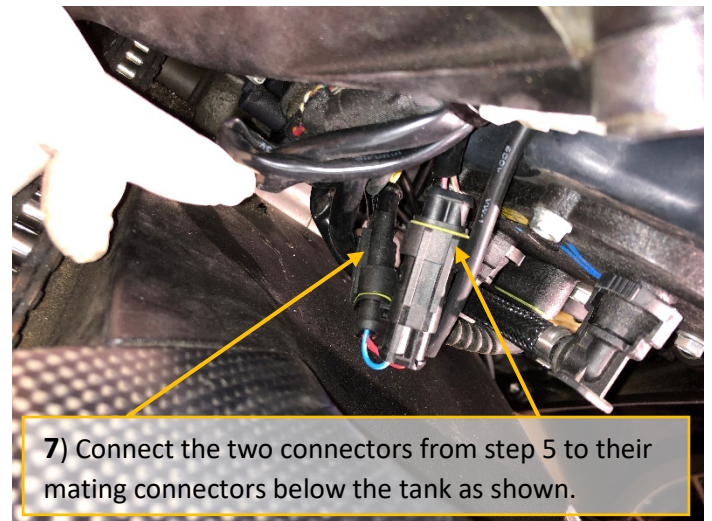

7) Connect the two connectors from step 5 to their mating connectors below the tank as shown.

(continued)



8) **NEATLY** tuck the connectors back up into place and reinstall lower cover, rear-set and exhaust.

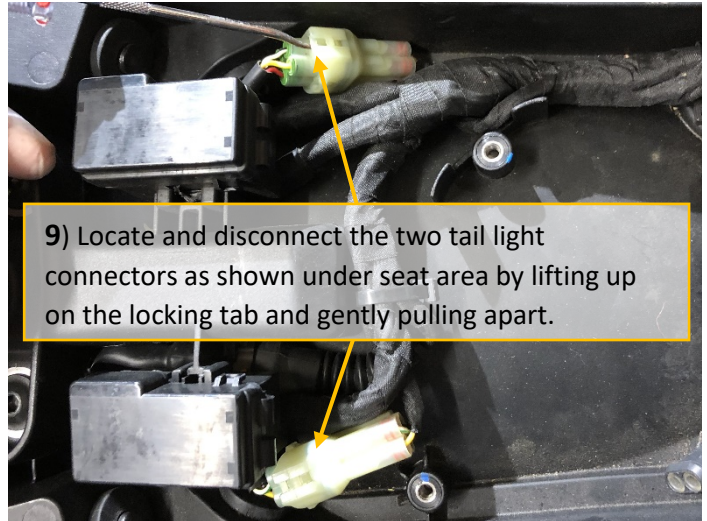

9) Locate and disconnect the two tail light connectors as shown under seat area by lifting up on the locking tab and gently pulling apart.



10) Connect the supplied harness to tail light connectors as shown.

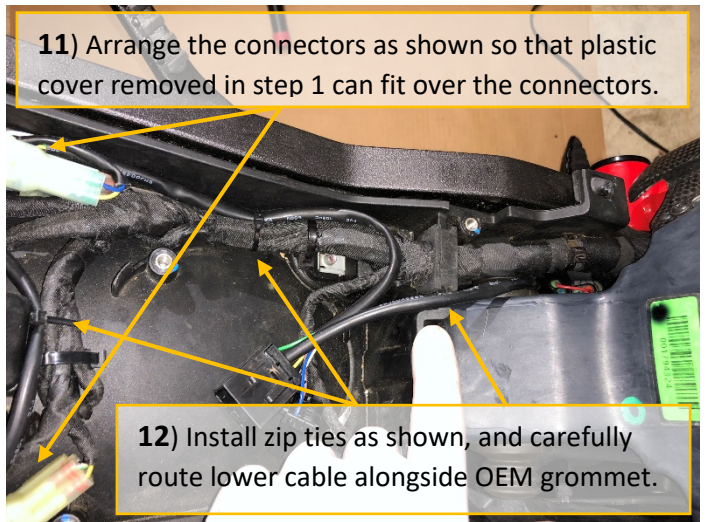

12) Install zip ties as shown, and carefully route lower cable alongside OEM grommet.

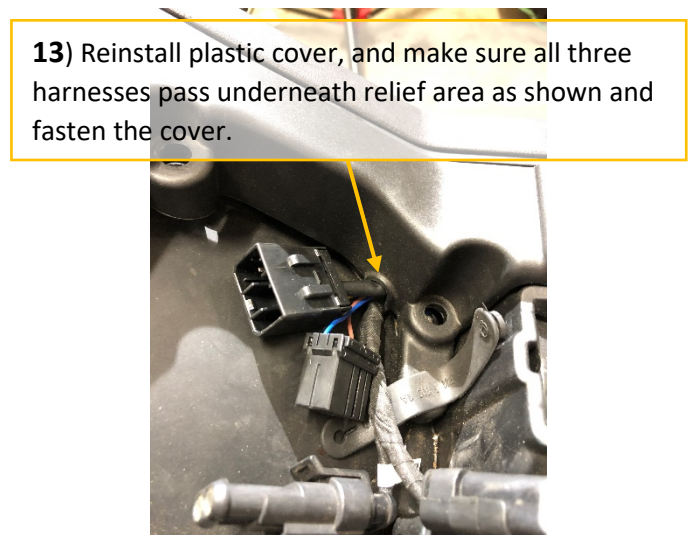

13) Reinstall plastic cover, and make sure all three harnesses pass underneath relief area as shown and fasten the cover.

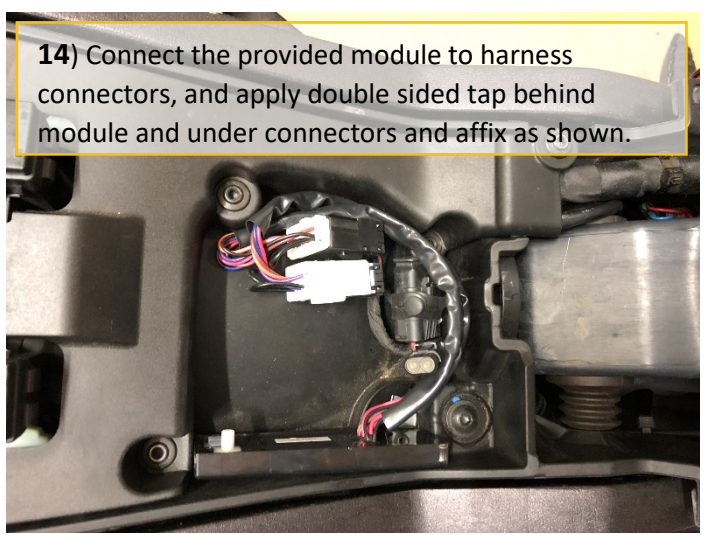

14) Connect the provided module to harness connectors, and apply double sided tap behind module and under connectors and affix as shown.

- 15) **Note:** Module has been changed from pictured, and has two extra small connectors which will be unused.
- 16) Reinstall wire strap on OEM diagnostic cable (removed step 1).
- 17) Return to Step 3 in "Installation" section of first page and follow remaining procedure.
- 18) Rant and Rave about Custom LED to everyone, and enjoy! 😊